



7590-7591

## Round Nose Tipped Pliers with Synthetic Handle





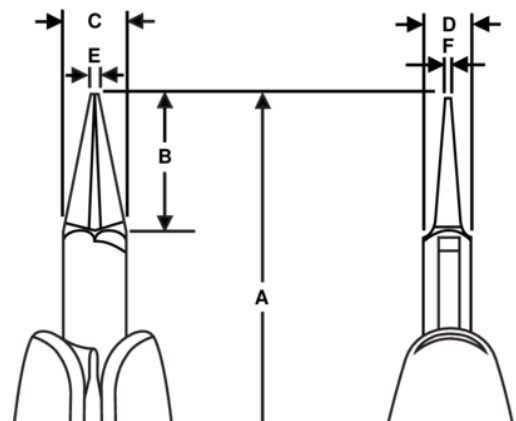

### PRODUCT DETAILS

- Supreme series round nose pliers
- Round jaws taper from 7 mm to 1.0 mm at the tip
- ESD safe mono-material handles with return spring
- High performance alloyed steel
- Polished finish
- Numerically controlled machine grinding guarantees accuracy & increases the tools reliability & consistency
- Tough hardened 42-46 HRC
- Screw joint that minimizes friction & maximizes jaw alignment
- Round jaws with no sharp edges
- 7591 with long tip







PRODUCT ATTRIBUTES

Product: **7590**

|   |               |   |             |   |             |
|---|---------------|---|-------------|---|-------------|
|  | Round<br>Nose |  | S           | <b>A</b>  | 146.5<br>mm |
| <b>A</b>  | 5.77<br>in    | <b>B</b>  | 20 mm       | <b>B</b>  | 0.79 in     |
| <b>C</b>  | 9 mm          | <b>C</b>  | 0.35 in     | <b>D</b>  | 6 mm        |
| <b>D</b>  | 0.24<br>inch  | <b>E</b>  | 1.4 mm      | <b>E</b>  | 0.055<br>in |
| <b>F</b>  | 0.7<br>mm     | <b>F</b>  | 0.027 in    |  | Smooth      |
|  | 69 g          | <b>Ω</b>  | Dissipative |   |             |

Product: **7591**

|   |               |   |             |   |             |
|---|---------------|---|-------------|---|-------------|
|  | Round<br>Nose |  | M           | <b>A</b>  | 165<br>mm   |
| <b>A</b>  | 6.5 in        | <b>B</b>  | 38.5 mm     | <b>B</b>  | 1.51 in     |
| <b>C</b>  | 9 mm          | <b>C</b>  | 0.35 in     | <b>D</b>  | 6.7 mm      |
| <b>D</b>  | 0.24<br>inch  | <b>E</b>  | 1.4 mm      | <b>E</b>  | 0.055<br>in |
| <b>F</b>  | 0.7<br>mm     | <b>F</b>  | 0.027 in    |  | Smooth      |
|  | 75 g          | <b>Ω</b>  | Dissipative |   |             |