



CO8248

**Long Flush Precision Cut 45°
Angle Tapered & Relieved Head
Oblique Cutter with Conductive
Material Handle 0.2 mm-0.8 mm**







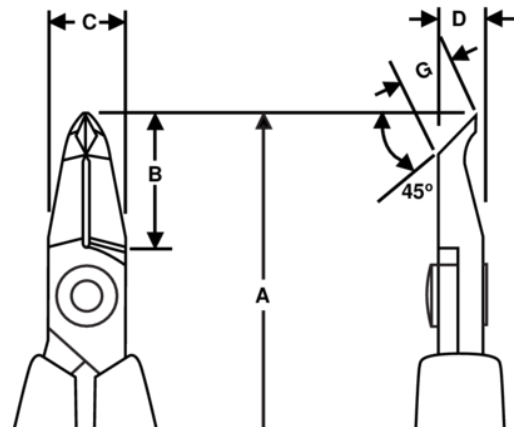

PRODUCT DETAILS

- Material: High performance alloy steel
- Exacting induction hardened edges 63–65 HRC
- ESD safe handles in synthetic material with leaf springs
- Precision screw joint that minimizes friction and maximizes alignment of cutting edges
- Cutting capacity is listed for solid copper wire



PRODUCT ATTRIBUTES

Product: **CO8248**

	Angle 45°		S	A	117.5 mm
A	4.63 in	B	18 mm	B	0.71 in
C	10 mm	C	0.39 in	D	6 mm
D	0.24 inch	G	6.7 mm	G	0.26 in
	0.2-0.8 mm		0.01-0.03 in		Flush
	51 g	Ω	Conductive		