



HS-7280

Long Flush Precision Cut Reverse Angle Oblique Cutter 0.2 mm-0.8 mm







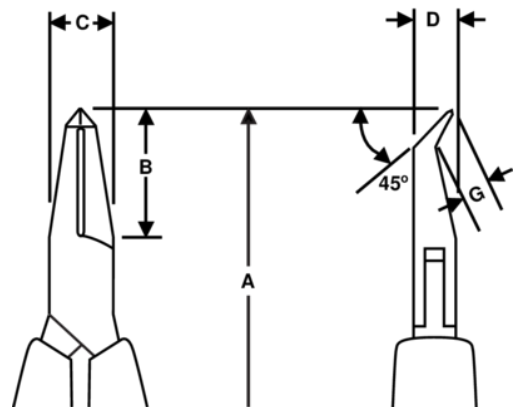

PRODUCT DETAILS

- Long, foam covered handles provide added leverage, an ergonomic grip, and reduced fatigue
- HS handle option can be applied to any standard 80 Series cutters or Supreme Series cutters and pliers
- All HS cutters and pliers are ESD safe, using static dissipative foam grips over conductive spring holders
- Contact Lindström for additional options



PRODUCT ATTRIBUTES

Product: **HS-7280**

	Angle 45°		S	A	150.3 mm
A	5.91 in	B	18 mm	B	0.71 in
C	9 mm	C	0.35 in	D	6 mm
D	0.24 inch	G	3.5 mm	G	0.14 in
	0.2-0.8 mm		0.01-0.03 in		Flush
	102 g	Ω	Dissipative		