



## RX8147PS

**Precision Diagonal Cutters with Tapered Head & ESD Safe Handle for hard materials**







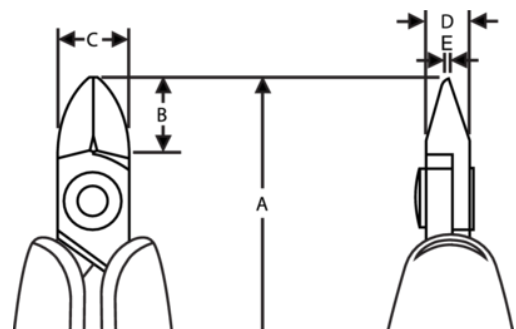

### PRODUCT DETAILS

- Products designed to get precise cuts on guidewires, catheter coil wires and cardiology and urology stents
- Hard wire cutters can be used on single or multiple filars and for lateral or internal coil cuts
- Sharp, fully aligned cutting edges
- Material: High performance alloy steel
- Precision induction hardened edges 63-65 HRC
- Screw joint minimizes friction and maximizes alignment of cutting edges
- ESD safe handles in synthetic material with return spring
- Numerically controlled machining guarantees edge angle accuracy and contact, increasing the tools reliability and consistency



PRODUCT ATTRIBUTES

Product: **RX8147PS**

	Tapered & Relieved		S	<b>A</b>	135.5 mm
<b>A</b>	5.33 in	<b>B</b>	10.5 mm	<b>B</b>	0.41 in
<b>C</b>	10 mm	<b>C</b>	0.39 in	<b>D</b>	6 mm
<b>D</b>	0.24 inch	<b>E</b>	0.8 mm	<b>E</b>	0.03 in
	0.1-0.8 mm		0.004-0.03 in		Flush
	68 g				