



RX-7890-RX-7891

ERGO™ Snipe Nose Pliers with Dual-Component Synthetic Handle



PRODUCT DETAILS



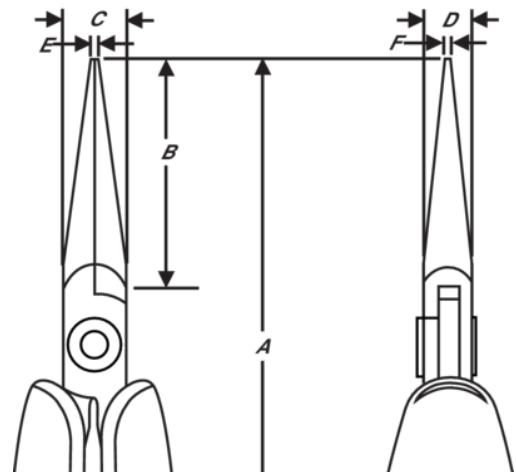

- Two-component ESD Safe Ergo™ handles: thermoplastic surface on tough polypropylene provides superior grip
- Polished and tough hardened cutting edges to 55-58 HRC
- Precision screw joint minimizes friction and maximizes alignment of cutting edges

- Micro-Touch™: The shape of the handles makes it possible to control and rotate the pliers between thumb and index finger for precision work
- Biospring® reduces tension throughout the working cycle of the tool and can be adjusted in three different positions







PRODUCT ATTRIBUTES

Product: **RX7890**

	Chain Nose		S	A	158.5 mm
A	6.24 in	B	32 mm	B	1.26 in
C	9 mm	C	0.35 in	D	6 mm
D	0.24 inch	E	1.2 mm	E	0.05 in
F	0.8 mm	F	0.03 in		Smooth
	72 g				

Product: **RX-7891**

	Chain Nose		S	A	158.5 mm
A	6.24 in	B	32 mm	B	1.26 in
C	9 mm	C	0.35 in	D	6 mm
D	0.24 inch	E	1.2 mm	E	0.05 in
F	0.8 mm	F	0.03 in		Serrated
	72 g				