



## RX8137

### Flush Precision Cut Diagonal Cutter with Tapered & Relieved Head & ESD Safe Handle 0.1-0.8 mm







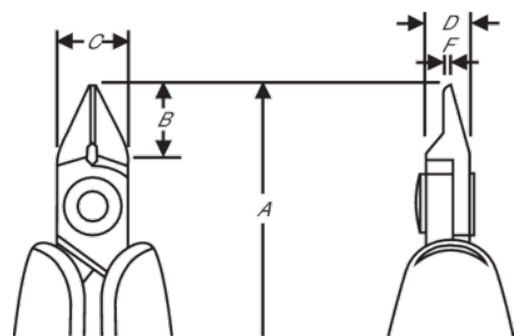

#### PRODUCT DETAILS

- Ideal for use in confined spaces and for rework
- Two-component Ergo™ handles: thermoplastic surface on tough polypropylene provides superior grip
- Material: High performance alloy steel
- Precision induction hardened cutting edges to 63–65 HRC
- ESD safe handles in 2-component synthetic material
- Micro-Touch™: The shape of the handles makes it possible to control and rotate the pliers between thumb and index finger for precision work
- Precision screw joint that minimizes friction and maximizes alignment of cutting edges
- Biospring® reduces tension throughout the working cycle of the tool and can be adjusted in three different positions
- Cutting capacity is listed for solid copper wire
- Phosphated finish



PRODUCT ATTRIBUTES

Product: **RX8137**

	Tapered & Relieved		XS	<b>A</b>	108.0 mm
<b>A</b>	4.25 in	<b>B</b>	8 mm	<b>B</b>	0.31 in
<b>C</b>	8 mm	<b>C</b>	0.31 in	<b>D</b>	5 mm
<b>D</b>	0.2 inch	<b>F</b>	0.8 mm	<b>F</b>	0.03 in
	0.1-0.8 mm		0.004-0.03 in		Flush
	66 g	<b>Ω</b>	Dissipative		