



RX-8152

Ergo™ Ultra-Flush® Precision Cut Diagonal Cutter with Oval Head 0.2-1.25 mm







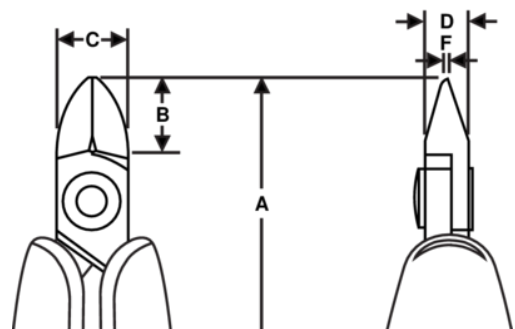

PRODUCT DETAILS

- Ideal for cutting leads, jewelry wire, and general assembly applications
- Two-component ESD safe Ergo™ handles: Thermoplastic surface on tough polypropylene provides superior grip
- Material: High performance alloy steel
- Precision induction hardened cutting edges 63–65 HRC
- Micro-Touch™: The shape of the handles makes it possible to control and rotate the pliers between thumb and index finger for precision work
- Precision screw joint minimizes friction and maximizes alignment of cutting edges
- Biospring® reduces tension throughout the working cycle of the tool and can be adjusted in three different positions
- Cutting capacity is listed for solid copper wire
- Burnished finish



PRODUCT ATTRIBUTES

Product: **RX-8152**

	Oval		M	A	138.0 mm
A	5.43 in	B	13 mm	B	0.51 in
C	12.5 mm	C	0.49 in	D	6 mm
D	0.24 inch	F	1.2 mm	F	0.05 in
	0.2-1.25 mm		0.00-0.05 in		Ultra-Flush ®
	73 g	Ω	Dissipative		