



RX-8141

Ergo™ Flush Precision Cut Diagonal Cutter with Oval Head 0.1-1.25 mm







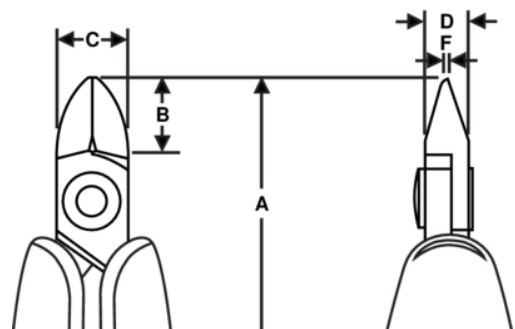

PRODUCT DETAILS

- Ideal for cutting leads, jewelry wire, and general assembly applications
- Two-component ESD safe Ergo™ handles: Thermoplastic surface on tough polypropylene provides superior grip
- Material: High performance alloy steel
- Precision induction hardened cutting edges 63–65 HRC
- Micro-Touch™: The shape of the handles makes it possible to control and rotate the pliers between thumb and index finger for precision work
- Precision screw joint minimizes friction and maximizes alignment of cutting edges
- Biospring® reduces tension throughout the working cycle of the tool and can be adjusted in three different positions
- Cutting capacity is listed for solid copper wire
- Burnished finish



PRODUCT ATTRIBUTES

Product: **RX-8141**

	Oval		S	A	135.5 mm
A	5.33 in	B	10.5 mm	B	0.41 in
C	10 mm	C	0.39 in	D	6 mm
D	0.24 inch	F	0.8 mm	F	0.03 in
	0.1-1.25 mm		0.00-0.05 in		Flush
	70 g	Ω	Dissipative		