



RX-8131

Ergo™ Flush Precision Cut Diagonal Cutter with Oval Head 0.1-1 mm







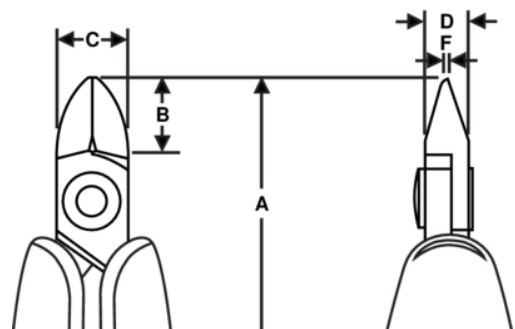

PRODUCT DETAILS

- Ideal for cutting leads, jewelry wire, and general assembly applications
- Two-component ESD safe Ergo™ handles: Thermoplastic surface on tough polypropylene provides superior grip
- Material: High performance alloy steel
- Precision induction hardened cutting edges 63–65 HRC
- Micro-Touch™: The shape of the handles makes it possible to control and rotate the pliers between thumb and index finger for precision work
- Precision screw joint minimizes friction and maximizes alignment of cutting edges
- Biospring® reduces tension throughout the working cycle of the tool and can be adjusted in three different positions
- Cutting capacity is listed for solid copper wire
- Burnished finish



PRODUCT ATTRIBUTES

Product: **RX-8131**

	Oval		XS	A	133.5 mm
A	5.25 in	B	8.5 mm	B	0.33 in
C	8 mm	C	0.31 in	D	5 mm
D	0.2 inch	F	0.8 mm	F	0.03 in
	0.1-1.0 mm		0.00 - 0.04 in		Flush
	68 g	Ω	Dissipative		