



RX8211

Ergo™ Flush Cut Short Precision 20° Angle Head Oblique Cutter 0.2 mm-1.2 mm







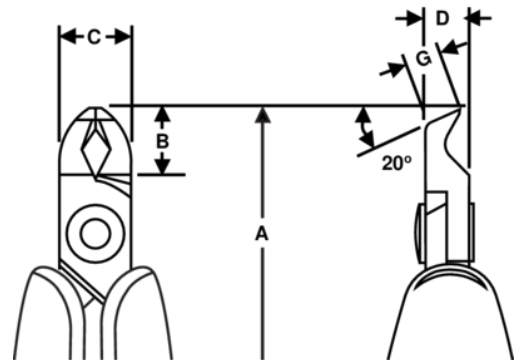

PRODUCT DETAILS

- Ideal for assembly work where accessibility is a consideration
- Developed according to the ERGO® process for a comfortable and effective grip in all situations
- Material: High performance alloy steel
- Precision induction hardened edges 63–65 HRC
- ESD safe handles in 2-component synthetic material
- Precision screw joint that minimizes friction and maximizes alignment of cutting edges
- Biospring® reduces tension throughout the working cycle of the tool and can be adjusted in three different positions
- Cutting capacity is listed for solid copper wire
- Burnished finish



PRODUCT ATTRIBUTES

Product: **RX8211**

	Angle 20°		S	A	134.5 mm
A	5.29 in	B	9.5 mm	B	0.37 in
C	10 mm	C	0.39 in	D	6 mm
D	0.24 inch	G	4.1 mm	G	0.16 in
	0.2-1.2 mm		0.01-0.05 in		Flush
	70 g	Ω	Dissipative		