



RX-7490

**ERGO™ Precision Flat Nose
Stubby Pliers with Dual-
Component Synthetic Handle**





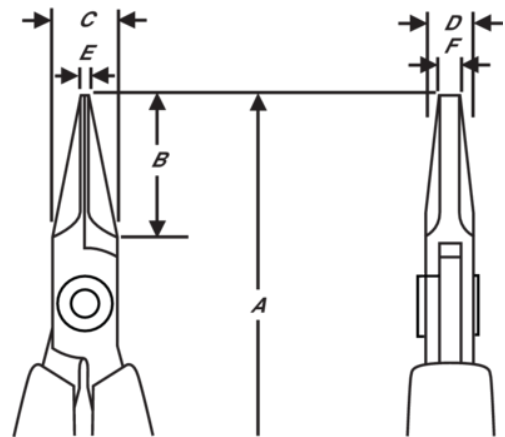

PRODUCT DETAILS

- Two-component Ergo™ handles: Thermoplastic surface on tough polypropylene provides superior grip
- Material: High performance alloy steel
- Polished and tough hardened 55-58 HRC
- Precision screw joint that minimizes friction and maximizes alignment of cutting edges
- Micro-Touch™: The shape of the handles makes it possible to control and rotate the pliers between thumb and index finger for precision work
- Biospring® reduces tension throughout the working cycle of the tool and can be adjusted in three different positions
- Burnished finish







PRODUCT ATTRIBUTES





Product: **RX7390**

	Flat Nose Stubby		S	A	137 mm
A	5.40 in	B	11 mm	B	0.43 in
C	10 mm	C	0.39 in	D	6 mm
D	0.24 inch	E	6 mm	E	0.24 in
F	0.8 mm	F	0.07 in		Smooth
		Ω	Dissipative		

Product: **RX7392**

	Oblique, Stubby		S	A	137 mm
A	5.40 in	B	12 mm	B	0.48 in
C	10 mm	C	0.39 in	D	6 mm
D	0.24 inch	E	6 mm	E	0.24 in
F	1.6 mm	F	0.07 in		Smooth
	70 g	Ω	Dissipative		

Product: **RX-7490**

	Flat Nose		S	A	146.5 mm
A	5.77 in	B	20 mm	B	0.79 in
C	9 mm	C	0.35 in	D	6.7 mm
D	0.26 inch	E	1.2 mm	E	0.05 in
F	3.2 mm	F	0.12 in		Smooth
	70 g	Ω	Dissipative		