



HS-7890-HS-7891

Long Snipe Nose Pliers with Dual-Component Synthetic Handle



PRODUCT DETAILS



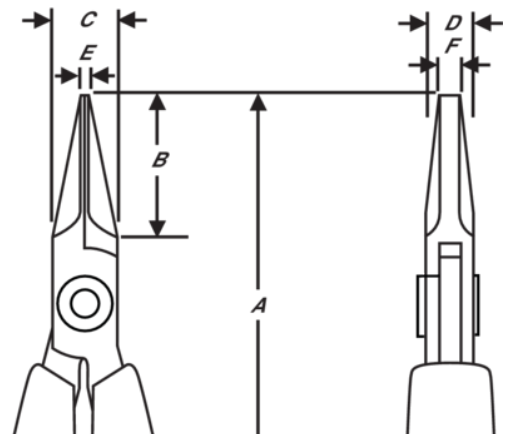

- Long, foam covered handles provide added leverage, an ergonomic grip, and reduced fatigue
- HS handle option can be applied to any standard 80 Series cutters or Supreme Series cutters and pliers

- All HS cutters and pliers are ESD safe, using static dissipative foam grips over conductive spring holders







PRODUCT ATTRIBUTES

Product: **HS-7890**

	Chain Nose		M	A	164.3 mm
A	6.47 in	B	32 mm	B	1.26 in
C	9 mm	C	0.35 in	D	6 mm
D	0.24 inch	E	1.2 mm	E	0.05 in
F	0.8 mm	F	0.03 in		Smooth
	105 g				

Product: **HS-7891**

	Chain Nose		M	A	164.3 mm
A	6.47 in	B	32 mm	B	1.26 in
C	9 mm	C	0.35 in	D	6 mm
D	0.24 inch	E	1.2 mm	E	0.05 in
F	0.8 mm	F	0.03 in		Serrated
	106 g				