



HS-8248

Long Precision 45° Tapered & Relieved Head Oblique Cutters 0.2 mm-0.8 mm







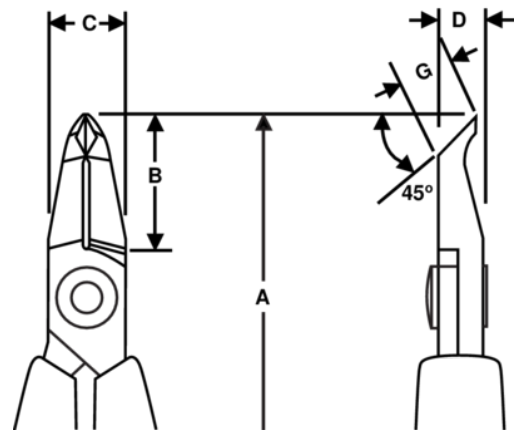

PRODUCT DETAILS

- Long, foam covered handles provide added leverage, an ergonomic grip, and reduced fatigue
- HS handle option can be applied to any standard 80 Series cutters or Supreme Series cutters and pliers
- All HS cutters and pliers are ESD safe, using static dissipative foam grips over conductive spring holders



PRODUCT ATTRIBUTES

Product: **HS-8248**

	Tapered & Relieved		L	A	149.8 mm
A	5.90 in	B	18 mm	B	0.71 in
C	10 mm	C	0.39 in	D	8 mm
D	0.31 inch	G	6.7 mm	G	0.26 in
	0.2-0.8 mm		0.01-0.03 in		Flush
	99 g	Ω	Dissipative		