



RX8156

Ergo™ Micro-Bevel® Precision Cut Diagonal Cutter with Tapered & Relieved Head 0.3-1.25 mm







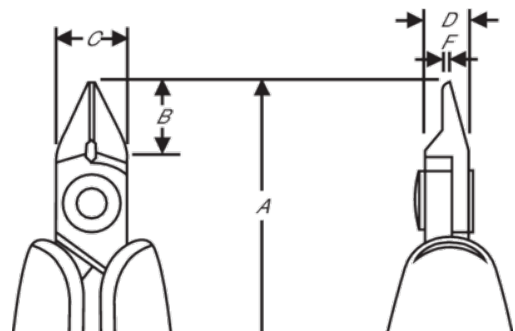

PRODUCT DETAILS

- Ideal for use in confined spaces and for rework
- Two-component Ergo™ handles: thermoplastic surface on tough polypropylene provides superior grip
- Material: High performance alloy steel
- Precision induction hardened cutting edges to 63–65 HRC
- ESD safe handles in 2-component synthetic material
- Micro-Touch™: The shape of the handles makes it possible to control and rotate the pliers between thumb and index finger for precision work
- Precision screw joint that minimizes friction and maximizes alignment of cutting edges
- Biospring® reduces tension throughout the working cycle of the tool and can be adjusted in three different positions
- Cutting capacity is listed for solid copper wire
- Phosphated finish



PRODUCT ATTRIBUTES

Product: **RX8156**

	Tapered & Relieved		M	A	138.0 mm
A	5.30 in	B	13 mm	B	0.51 in
C	12.5 mm	C	0.49 in	D	6 mm
D	0.24 inch	F	1.2 mm	F	0.05 in
	0.3-1.25 mm		0.01-0.05 in		Micro-Bevel®
	70 g	Ω	Dissipative		