



### HS-8247

Long Flush Precision Cut 45°  
Angle Tapered Head Oblique  
Cutter 0.2 mm-1 mm







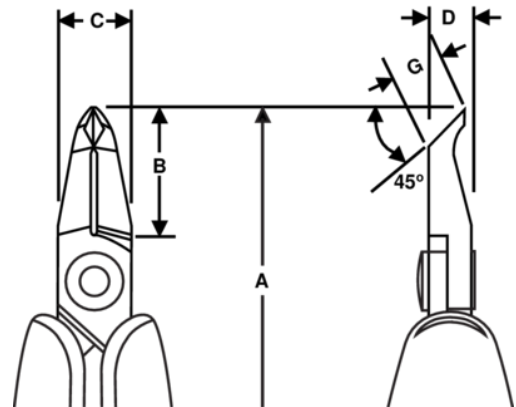

### PRODUCT DETAILS

- Long, foam covered handles provide added leverage, an ergonomic grip, and reduced fatigue
- HS handle option can be applied to any standard 80 Series cutters or Supreme Series cutters and pliers
- All HS cutters and pliers are ESD safe, using static dissipative foam grips over conductive spring holders



PRODUCT ATTRIBUTES

Product: **HS-8247**

	Angle 45°		L	<b>A</b>	149.8 mm
<b>A</b>	5.90 in	<b>B</b>	18 mm	<b>B</b>	0.71 in
<b>C</b>	10 mm	<b>C</b>	0.39 in	<b>D</b>	8 mm
<b>D</b>	0.31 inch	<b>G</b>	6.7 mm	<b>G</b>	0.26 in
	0.2-1.0 mm		0.01-0.04 in		Flush
	99 g	<b>Ω</b>	Dissipative		