



**CO8247**

**Flush Precision Cut 45° Angle  
Tapered Head Oblique Cutter with  
Conductive Material Handle 0.2  
mm-1 mm**







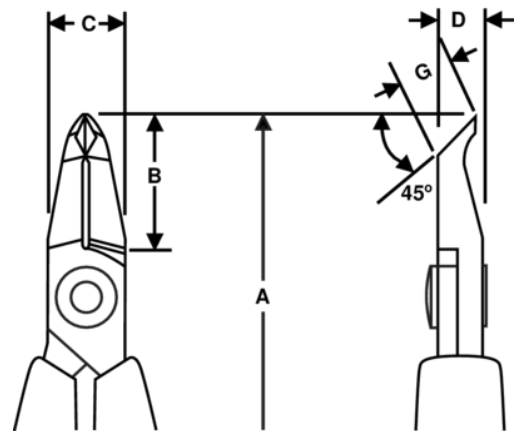

## PRODUCT DETAILS

- Material: High performance alloy steel
- Exacting induction hardened edges 63–65 HRC
- ESD safe handles in synthetic material with leaf springs
- Precision screw joint minimizes friction and maximizes alignment of cutting edges
- Cutting capacity is listed for solid copper wire
- Burnished finish



PRODUCT ATTRIBUTES

Product: **CO8247**

	Angle 45°		S	<b>A</b>	117.5 mm
<b>A</b>	4.63 in	<b>B</b>	18 mm	<b>B</b>	0.71 in
<b>C</b>	10 mm	<b>C</b>	0.39 in	<b>D</b>	6 mm
<b>D</b>	0.24 inch	<b>G</b>	6.7 mm	<b>G</b>	0.26 in
	0.2-1.0 mm		0.01-0.04 in		Flush
	51 g	<b>Ω</b>	Conductive		