



8136-8168

**Precision Diagonal Cutters with
Tapered Head & Relieved & ESD
Safe Handle**





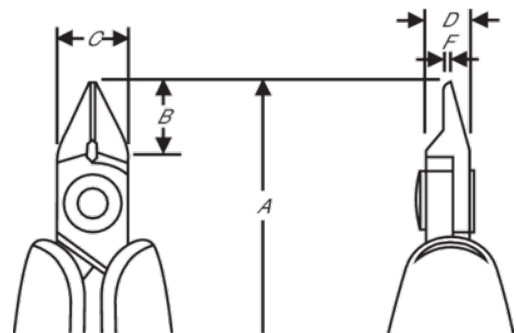

PRODUCT DETAILS

- Material: High performance alloy steel
- Exacting induction hardened edges 63–65 HRC
- ESD safe handles in synthetic material with leaf springs
- Precision screw joint that minimizes friction and maximizes alignment of cutting edges
- Cutting capacity is listed for solid copper wire







PRODUCT ATTRIBUTES





Product: 8136

	Tapered & Relieved		XS		Micro-Bevel®
	0.1-0.8 mm		0.004-0.03 in	A	108 mm
A	4.25 in	B	8 mm	B	0.31 in
C	8 mm	C	0.31 in	D	5 mm
D	0.2 inch	F	0.6 mm	F	0.02 in
g	43 g	Ω	Dissipative		





Product: 8137

	Tapered & Relieved		XS		Flush
	0.1-0.8 mm		0.004-0.03 in	A	108 mm
A	4.25 in	B	8 mm	B	0.31 in
C	8 mm	C	0.31 in	D	5 mm
D	0.2 inch	F	0.6 mm	F	0.02 in
g	43 g	Ω	Dissipative		





Product: 8138

	Tapered & Relieved		XS		Ultra-Flush®
	0.1-0.5 mm		0.004-0.02 in	A	108 mm
A	4.25 in	B	8 mm	B	0.31 in
C	8 mm	C	0.31 in	D	5 mm
D	0.2 inch	F	0.6 mm	F	0.02 in
g	43 g	Ω	Dissipative		





Product: 8146

	Tapered & Relieved		S		Micro-Bevel®
	0.2-1.0 mm		0.01-0.04 in	A	110.5 mm
A	4.33 in	B	10 mm	B	0.39 in
C	10 mm	C	0.39 in	D	6 mm
D	0.24 inch	F	0.8 mm	F	0.03 in
g	46 g	Ω	Dissipative		





Product: 8147

	Tapered & Relieved		S		Flush
	0.1-1.0 mm		0.01-0.04 in	A	110.5 mm
A	4.33 in	B	10 mm	B	0.39 in
C	10 mm	C	0.39 in	D	6 mm
D	0.24 inch	F	0.8 mm	F	0.03 in
g	46 g	Ω	Dissipative		

Product: 8148

	Tapered & Relieved		S		Ultra-Flush®
	0.1-0.8 mm		0.00-0.03 in	A	110.5 mm
A	4.33 in	B	10 mm	B	0.39 in
C	10 mm	C	0.39 in	D	6 mm
D	0.24 inch	F	0.8 mm	F	0.03 in
g	45 g	Ω	Dissipative		

Product: 8166L

	Tapered & Relieved		L		Micro-Bevel®
	0.4-1.5 mm		0.02-0.06 in	A	125 mm
A	4.92 in	B	16 mm	B	0.63 in
C	16 mm	C	0.63 in	D	8 mm
D	0.31 inch	F	1.6 mm	F	0.06 in
g	52 g	Ω	Dissipative		