



**P6160**  
**ERGO™ Precision Diagonal Plastic Cutters**







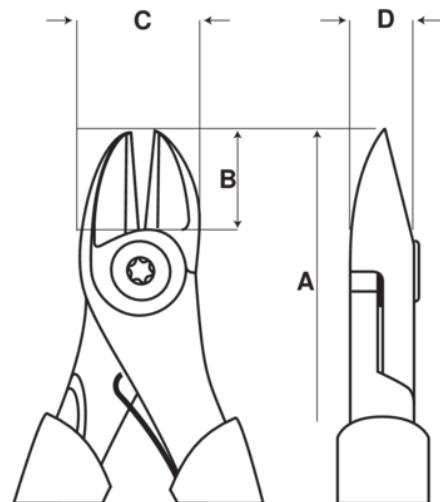



**PRODUCT DETAILS**

- Oval relieved cutting head for applications where access is limited
- Extremely strong construction for long lasting performance
- Designed to produce a Flush cut result on plastic, nylon and cabled wire applications
- Developed according to the ERGO® process for a comfortable and effective grip in all situations
- Rivet joint that minimizes friction and maximizes jaw alignment
- ESD safe handles in 2-component synthetic material
- On/off spring enables reduced profile for easy storage



PRODUCT ATTRIBUTES

Product: **P6160**

	Oval		L		Flush
	1.5 mm		0.059 in		3.0 mm
	0.118 in	<b>A</b>	160 mm	<b>A</b>	6.3 in
<b>B</b>	18 mm	<b>B</b>	0.7 in	<b>C</b>	21.5 mm
<b>C</b>	0.85 in	<b>D</b>	10 mm	<b>D</b>	0.39 inch
	162 g				