



7890-7891

Snipe Nose Pliers with Dual-Component Synthetic Handle





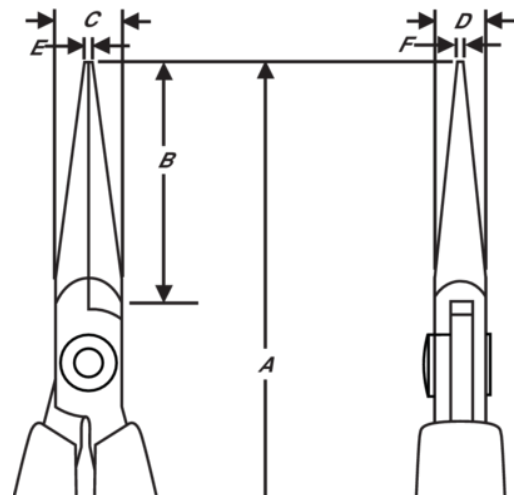

PRODUCT DETAILS

- Material: High performance alloy steel
- Polished and induction hardened to 58–60 HRC
- Precision screw joint that minimizes friction and maximizes jaw alignment
- ESD safe handles in synthetic material with leaf springs
- Natural finish







PRODUCT ATTRIBUTES

Product: 7890

	Chain Nose		M	A	132 mm
A	5.20 in	B	32 mm	B	1.26 in
C	9 mm	C	0.35 in	D	6 mm
D	0.24 inch	E	1.2 mm	E	0.05 in
F	0.8 mm	F	0.03 in		Smooth
	72 g	Ω	Dissipative		

Product: 7891

	Chain Nose		M	A	132 mm
A	5.20 in	B	32 mm	B	1.26 in
C	9 mm	C	0.35 in	D	6 mm
D	0.24 inch	E	1.2 mm	E	0.05 in
F	0.8 mm	F	0.03 in		Serrated
	72 g	Ω	Dissipative		