



**7280**

**Precision 45° Oblique Cutters 0.2 mm-08 mm**







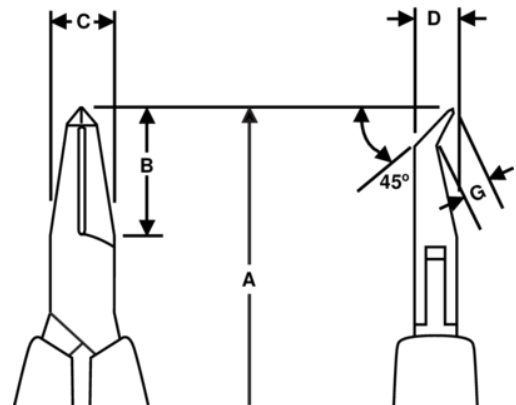

## PRODUCT DETAILS

- Material: High performance alloy steel
- Polished and precision induction hardened to 63–65 HRC
- Precision screw joint that minimizes friction and maximizes alignment of cutting edges
- ESD safe handles in synthetic material with leaf springs
- Cutting capacity is listed for solid cooper wire



PRODUCT ATTRIBUTES

Product: **7280**

	Angle 45°		S		Flush
	0.2-08 mm		0.01-0.03 in	<b>A</b>	120 mm
<b>A</b>	4.72 in	<b>B</b>	20 mm	<b>B</b>	0.79 in
<b>C</b>	9 mm	<b>C</b>	0.35 in	<b>D</b>	6 mm
<b>D</b>	0.24 inch	<b>F</b>	3.5 mm	<b>F</b>	0.14 in
	56 g	<b>Ω</b>	Dissipative		