



RX 8234
ERGO™ Precision Micro Tip
Cutters 141 mm







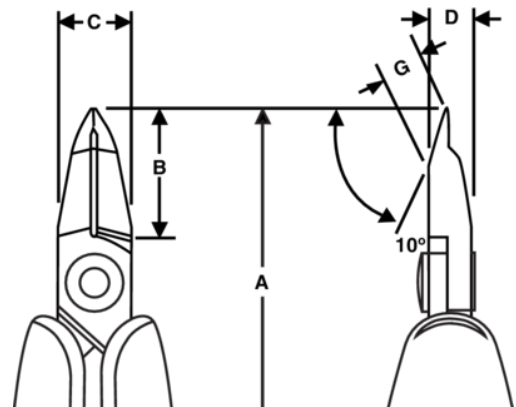

PRODUCT DETAILS

- Ideal for rework and close fine pitch Applications
- Developed according to the ERGO® process for a comfortable and effective grip in all situations
- Material: High performance alloy steel
- Precision induction hardened edges 63–65 HRC
- ESD safe handles in 2-component synthetic material
- Precision screw joint minimizes friction and maximizes alignment of cutting edges
- Biospring® reduces tension throughout the working cycle of the tool and can be adjusted in three different positions
- Cutting capacity listed is for solid copper wire
- Burnished finish



PRODUCT ATTRIBUTES

Product: **RX8234A**

	Micro Tip 10°		XS		Flush
	0.05-0.4 mm		0.002-0.018 in	A	141 mm
A	4.50 in	B	14.2 mm	B	0.56 in
C	10.6 mm	C	0.41 in	D	7 mm
D	0.27 inch	G	3.2 mm	G	0.12 in
	62 g		Dissipative		