



HS8211

Short Flush Precision Cut 20°
Angle Head Oblique Cutter 0.2
mm-1.2 mm







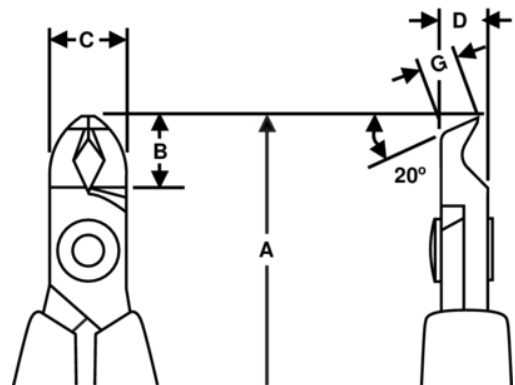

PRODUCT DETAILS

- Long, foam covered handles provide added leverage, an ergonomic grip, and reduced fatigue
- HS handle option can be applied to any standard 80 Series cutters or Supreme Series cutters and pliers
- All HS cutters and pliers are ESD safe, using static dissipative foam grips over conductive spring holders



PRODUCT ATTRIBUTES

Product: **HS8211**

	Angle 20°		L		Flush
	0.2-1.2 mm		0.01-0.05 in	A	5.60 mm
A	142.3 in	B	9.5 mm	B	0.37 in
C	10 mm	C	0.39 in	D	8 mm
D	0.31 inch	G	4.1 mm	G	0.16 in
	91 g		Dissipative		