



HS8147

Long Flush Precision Cut Diagonal Cutter with Tapered & Relieved Head & ESD Safe Handle 0.1-1 mm



PRODUCT DETAILS





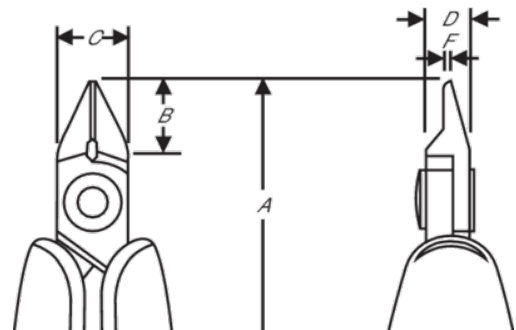

- Long, foam covered handles provide added leverage, an ergonomic grip, and reduced fatigue
- HS handle option can be applied to any standard 80 Series cutters or Supreme Series cutters and pliers

- All HS cutters and pliers are ESD safe, using static dissipative foam grips over conductive spring holders



PRODUCT ATTRIBUTES

Product: **HS8147**

	Tapered & Relieved		S		Flush
	0.1-1.0 mm		0.01-0.04 in	A	5.60 mm
A	142.3 in	B	10 mm	B	0.39 in
C	10 mm	C	0.39 in	D	6 mm
D	0.24 inch	F	0.8 mm	F	0.03 in
	91 g	Ω	Dissipative		