



HS8158

**Long Ultra-Flush® Precision Cut
Diagonal Cutter with Tapered &
Relieved Head & ESD Safe Handle
0.2-1 mm**







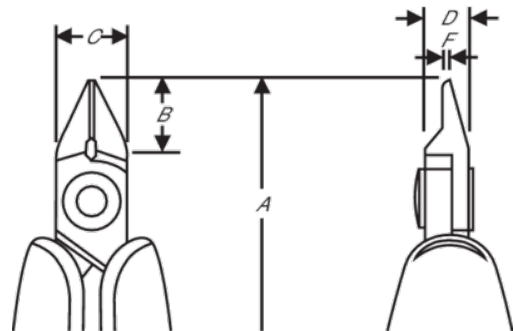

PRODUCT DETAILS

- Long, foam covered handles provide added leverage, an ergonomic grip, and reduced fatigue
- HS handle option can be applied to any standard 80 Series cutters or Supreme Series cutters and pliers
- All HS cutters and pliers are ESD safe, using static dissipative foam grips over conductive spring holders



PRODUCT ATTRIBUTES

Product: **HS8158**

	Tapered & Relieved		M		Ultra-Flush®
	0.2-1.0 mm		0.01-0.04 in	A	144.8 mm
A	5.70 in	B	12.5 mm	B	0.5 in
C	12.5 mm	C	0.49 in	D	6 mm
D	0.24 inch	F	1 mm	F	0.04 in
	97 g	Ω	Dissipative		