



8166L

**Micro-Bevel® Precision Cut
Diagonal Cutter with Tapered &
Relieved Head & ESD Safe Handle
0.4-1.5 mm**







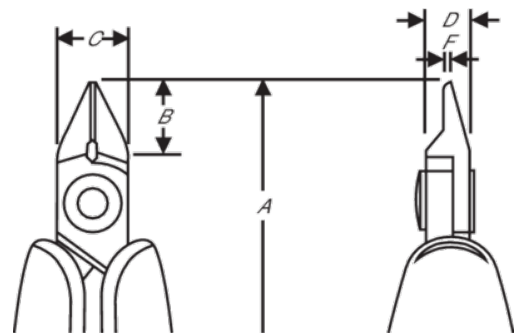

PRODUCT DETAILS

- Material: High performance alloy steel
- Exacting induction hardened edges 63–65 HRC
- ESD safe handles in synthetic material with leaf springs
- Precision screw joint that minimizes friction and maximizes alignment of cutting edges
- Cutting capacity is listed for solid copper wire



PRODUCT ATTRIBUTES

Product: **8166L**

	Tapered & Relieved		L		Micro-Bevel®
	0.4-1.5 mm		0.02-0.06 in	A	125 mm
A	4.92 in	B	16 mm	B	0.63 in
C	16 mm	C	0.63 in	D	8 mm
D	0.31 inch	F	1.6 mm	F	0.06 in
	52 g		Dissipative		