



8136

**Micro-Bevel® Precision Cut
Diagonal Cutter with Tapered &
Relieved Head & ESD Safe Handle
0.1-0.8 mm**







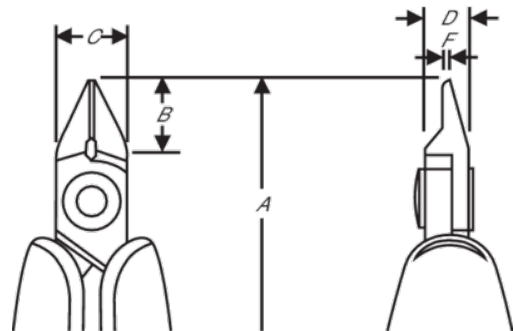
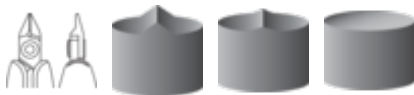

PRODUCT DETAILS

- Material: High performance alloy steel
- Exacting induction hardened edges 63–65 HRC
- ESD safe handles in synthetic material with leaf springs
- Precision screw joint that minimizes friction and maximizes alignment of cutting edges
- Cutting capacity is listed for solid copper wire



PRODUCT ATTRIBUTES

Product: **8136**

	Tapered & Relieved		XS		Micro-Bevel®
	0.1-0.8 mm		0.004-0.03 in	A	108 mm
A	4.25 in	B	8 mm	B	0.31 in
C	8 mm	C	0.31 in	D	5 mm
D	0.2 inch	F	0.6 mm	F	0.02 in
	43 g	Ω	Dissipative		