



RX8143PS

**Precision Micro Cut Diagonal
Cutter with Tapered Head & ESD
Safe Handle for hard materials**







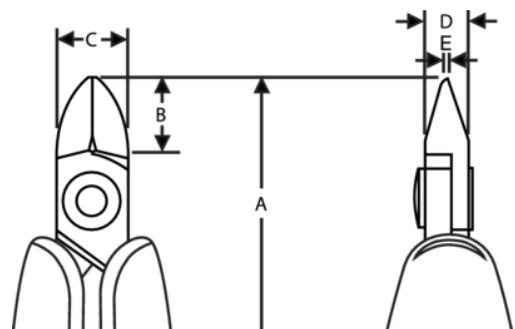

PRODUCT DETAILS

- Products designed to get precise cuts on guidewires, catheter coil wires and cardiology and urology stents
- Hard wire cutters can be used on single or multiple filars and for lateral or internal coil cuts
- Sharp, fully aligned cutting edges
- Material: High performance alloy steel
- Precision induction hardened edges 63-65 HRC
- Screw joint minimizes friction and maximizes alignment of cutting edges
- ESD safe handles in synthetic material with return spring
- Numerically controlled machining guarantees edge angle accuracy and contact, increasing the tools reliability and consistency



PRODUCT ATTRIBUTES

Product: **RX8143PS**

	Tapered		S		Flush
	0.1-1.0 mm		0.01-0.04 in	A	135.5 mm
A	5.33 in	B	10.5 mm	B	0.41 in
C	10 mm	C	0.39 in	D	6 mm
D	0.24 inch	E	0.8 mm	E	0.03 in
	70 g				