



RX8150PS

Precision Micro Cut Diagonal Cutter with Oval Head & ESD Safe Handle for hard materials







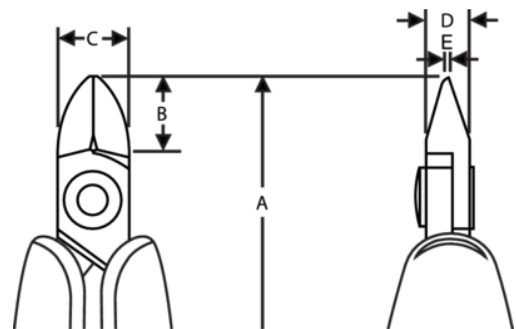



PRODUCT DETAILS

- PS Series precision oval head diagonal cutters developed according to the scientific ERGO™ process, Oval and robust head
- Designed to get the most precise cut on guidewires, catheter coil wires & cardiology & urology stents
- ERGO™ handles with two-component combination, thermoplastic surface, for comfortable grip, on tough polypropylene core for rigidity
- Micro-bevel cut
- Sharp & fully aligned edges
- High performance alloyed steel
- Phosphate finish
- Numerically controlled machine grinding guarantees edge angle accuracy & contact, increases the tool's reliability & consistency
- Precision induction-hardened edges 63-65 HRC
- Screw joint minimises friction & maximises alignment of cutting edges
- ESD safe handles in two-component synthetic material
- Bio spring limits the tension throughout the working cycle of the tool & can be adjusted to 3 different positions or removed
- Robust head for cutting multiple hard wire stents, guidewires and multiple catheter fillars



PRODUCT ATTRIBUTES

Product: **RX8150PS**

	Oval		M		Micro-Bevel®
	0.1-1.0 mm		0.01-0.04 in		0.2-0.8 mm
	0.01-0.03 in	A	135.5 mm	A	5.33 in
B	12.5 mm	B	0.5 in	C	12.5 mm
C	0.49 in	D	6 mm	D	0.24 inch
E	1.2 mm	E	0.05 in		70 g