



## RX8141PS

### Precision Flush Cut Diagonal Cutter with Oval Head & ESD Safe Handle for hard materials







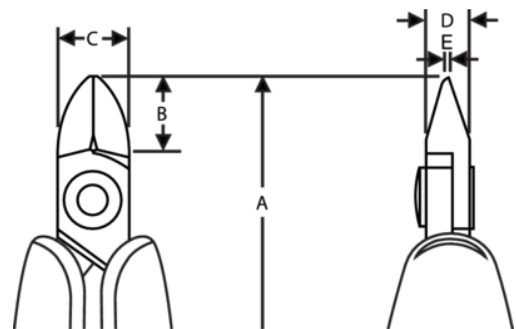



#### PRODUCT DETAILS

- PS Series precision oval head diagonal cutters developed according to the scientific ERGO™ process, Oval and robust head
- Designed to get the most precise cut on guidewires, catheter coil wires & cardiology & urology stents
- ERGO™ handles with two-component combination, thermoplastic surface, for comfortable grip, on tough polypropylene core for rigidity
- Micro-bevel cut
- Sharp & fully aligned edges
- High performance alloyed steel
- Phosphate finish
- Numerically controlled machine grinding guarantees edge angle accuracy & contact, increases the tool's reliability & consistency
- Precision induction-hardened edges 63-65 HRC
- Screw joint minimises friction & maximises alignment of cutting edges
- ESD safe handles in two-component synthetic material
- Bio spring limits the tension throughout the working cycle of the tool & can be adjusted to 3 different positions or removed
- Robust head for cutting multiple hard wire stents, guidewires and multiple catheter fillars



PRODUCT ATTRIBUTES

Product: **RX8141PS**

	Oval		S		Flush
	0.1-1.0 mm		0.01-0.04 in		0.2-0.5 mm
	0.01-0.02 in	<b>A</b>	135.5 mm	<b>A</b>	5.33 in
<b>B</b>	10.5 mm	<b>B</b>	0.41 in	<b>C</b>	10 mm
<b>C</b>	0.39 in	<b>D</b>	6 mm	<b>D</b>	0.24 inch
<b>E</b>	0.8 mm	<b>E</b>	0.03 in		70 g