



7191

Flush Cut Diagonal Cutter with
Tapered Head & ESD Safe Handle
0.1 mm-1 mm







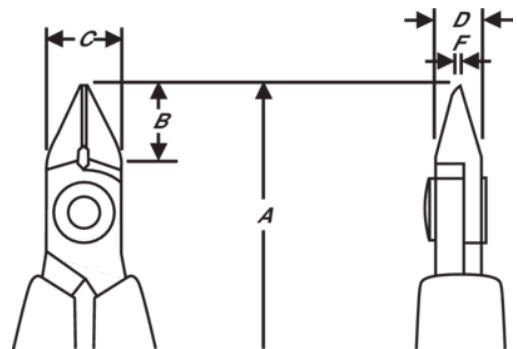

PRODUCT DETAILS

- Ideal for assembly work where access is a consideration
- Material: High performance alloy steel
- Polished and precision induction hardened to 63–65 HRC
- Precision screw joint minimizes friction and maximizes alignment of cutting edges
- ESD safe handles in synthetic material with leaf springs
- Cutting capacity is listed for solid copper wire



PRODUCT ATTRIBUTES

Product: **7191**

	Tapered		XS		Flush
	0.1-1.0 mm		0.00-0.04 in	A	108 mm
A	4.29 in	B	9 mm	B	0.35 in
C	9 mm	C	0.35 in	D	6 mm
D	0.24 inch	F	1 mm	F	0.04 in
	50 g	Ω	Dissipative		