



8149

Precision Diagonal Tip Cutter with  
ESD Safe Handle 0.1-0.6 mm







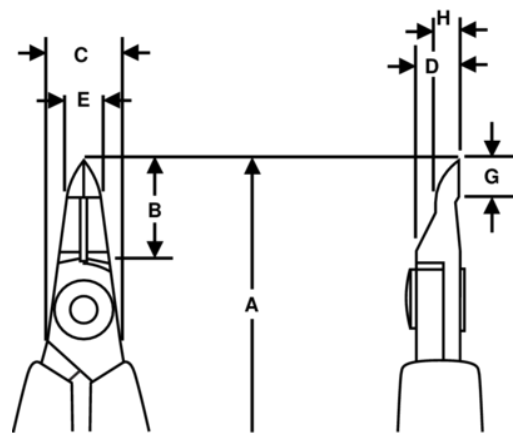

## PRODUCT DETAILS

- Material: High performance alloy steel
- Exacting induction hardened edges 63–65 HRC
- ESD safe handles in synthetic material with leaf springs
- Precision screw joint that minimizes friction and maximizes alignment of cutting edges
- Cutting capacity is listed for solid copper wire



PRODUCT ATTRIBUTES

Product: **8149**

	Tip Cutter		S		Flush
	0.1-0.6 mm		0.00-0.02 in	<b>A</b>	114 mm
<b>A</b>	4.49 in	<b>B</b>	14 mm	<b>B</b>	0.55 in
<b>C</b>	5 mm	<b>C</b>	0.23 in	<b>D</b>	6 mm
<b>D</b>	0.24 inch	<b>E</b>	5 mm	<b>E</b>	0.23 in
<b>G</b>	5 mm	<b>G</b>	0.23 in	<b>H</b>	3.2 mm
<b>H</b>	0.13 in		48 g	<b>Ω</b>	Dissipative