



8147

Flush Precision Cut Diagonal
Cutter with Tapered & Relieved
Head & ESD Safe Handle 0.1-1 mm







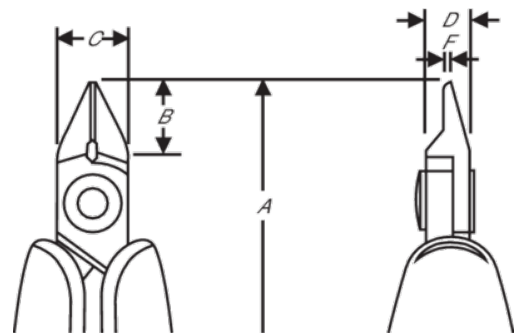

PRODUCT DETAILS

- Material: High performance alloy steel
- Exacting induction hardened edges 63–65 HRC
- ESD safe handles in synthetic material with leaf springs
- Precision screw joint that minimizes friction and maximizes alignment of cutting edges
- Cutting capacity is listed for solid copper wire



PRODUCT ATTRIBUTES

Product: **8147**

	Tapered & Relieved		S		Flush
	0.1-1.0 mm		0.01-0.04 in	A	110.5 mm
A	4.33 in	B	10 mm	B	0.39 in
C	10 mm	C	0.39 in	D	6 mm
D	0.24 inch	F	0.8 mm	F	0.03 in
	46 g	Ω	Dissipative		