



8146

**Micro-Bevel® Precision Cut  
Diagonal Cutter with Tapered &  
Relieved Head & ESD Safe Handle  
0.2-1 mm**







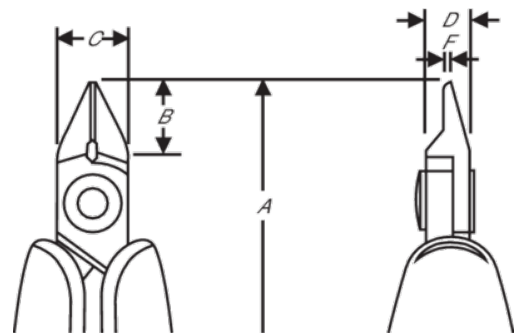

## PRODUCT DETAILS

- Material: High performance alloy steel
- Exacting induction hardened edges 63–65 HRC
- ESD safe handles in synthetic material with leaf springs
- Precision screw joint that minimizes friction and maximizes alignment of cutting edges
- Cutting capacity is listed for solid copper wire



PRODUCT ATTRIBUTES

Product: **8146**

	Tapered & Relieved		S		Micro-Bevel®
	0.2-1.0 mm		0.01-0.04 in	<b>A</b>	110.5 mm
<b>A</b>	4.33 in	<b>B</b>	10 mm	<b>B</b>	0.39 in
<b>C</b>	10 mm	<b>C</b>	0.39 in	<b>D</b>	6 mm
<b>D</b>	0.24 inch	<b>F</b>	0.8 mm	<b>F</b>	0.03 in
	46 g	<b>Ω</b>	Dissipative		