



RX8237A
Ergo™ Flush Precision Cut Micro
Tip Cutter 144 mm







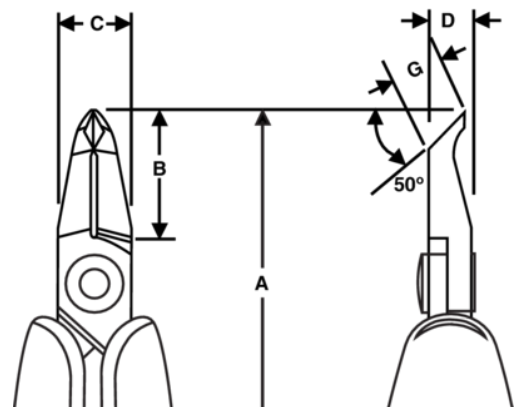

PRODUCT DETAILS

- Ideal for rework and close fine pitch Applications
- Developed according to the ERGO® process for a comfortable and effective grip in all situations
- Material: High performance alloy steel
- Precision induction hardened edges 63–65 HRC
- ESD safe handles in 2-component synthetic material
- Precision screw joint minimizes friction and maximizes alignment of cutting edges
- Biospring® reduces tension throughout the working cycle of the tool and can be adjusted in three different positions
- Cutting capacity listed is for solid copper wire
- Burnished finish



PRODUCT ATTRIBUTES

Product: **RX8237A**

	Angle 50°		XS		Flush
	0.1-0.5 mm		0.004-0.02 in	A	144 mm
A	5.6 in	B	17.4 mm	B	0.69 in
C	10.6 mm	C	0.41 in	D	7 mm
D	0.27 inch	G	4.1 mm	G	0.16 in
	65 g		Dissipative		