



HS 7890-HS 7891

Spetstång med långa käftar och handtag av syntetmaterial





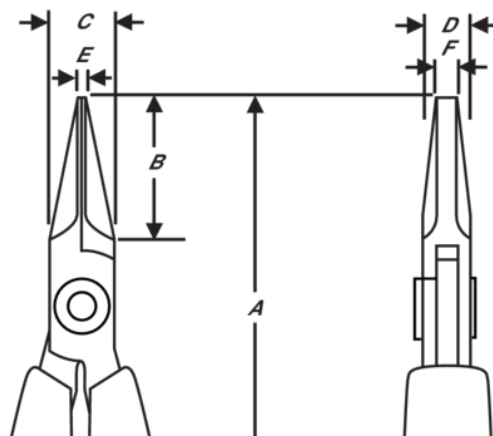

PRODUKTINFORMATION

- Spetstång i HS-serien
- ESD-säkra långa handtag med skumplastyta, samt retur fjäder
- Högkvalitativ stållegering
- Polerad yta
- Numeriskt styrd maskinslipning som garanterar precisionen och ökar verktygets pålitlighet och likformighet
- Härdad till 42-46 HRC
- Skruvad led som minskar friktionen och maximerar käftlinjeringen
- 32 mm långa käftar med avrundade kanter







PRODUKTATTRIBUT

Produkt: **HS 7890**

	Chain Nose		M	A	164.3 mm
A	6.47 in	B	32 mm	B	1.26 in
C	9 mm	C	0.35 in	D	6 mm
D	0.24 inch	E	1.2 mm	E	0.05 in
F	0.8 mm	F	0.03 in		Smooth
	105 g	Ω	Dissipative		

Produkt: **HS 7891**

	Chain Nose		M	A	164.3 mm
A	6.47 in	B	32 mm	B	1.26 in
C	9 mm	C	0.35 in	D	6 mm
D	0.24 inch	E	1.2 mm	E	0.05 in
F	0.8 mm	F	0.03 in		Serrated
	106 g	Ω	Dissipative		