



HS 7280

**Snedavbitare, omvänd vinkel,
långa skär, klippkapacitet 0,2 - 0,8
mm**



PRODUKTINFORMATION





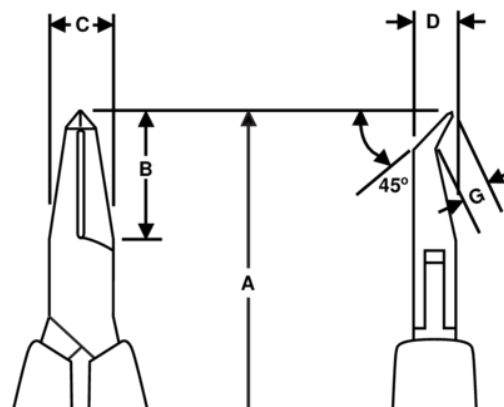

- Snedavbitare i HS-serien med omvänd vinkel
- ESD-säkra långa handtag med skumplastyta, samt retur fjäder
- Plant snitt
- Klippkapaciteten avser koppartråd
- Passar för klippning av koppar
- Högkvalitativ stållegering

- Polerad yta
- Numeriskt styrd maskinslipning som garanterar precisionen på eggvinkel och kontakt, vilket ökar verktygets pålitlighet och likformighet
- Precisionsinduktionshärdad egg, 63-65 HRC
- Skruvad led som minskar friktionen och maximerar käftlinjeringen
- Idealisk för arbete i trånga utrymmen



PRODUKTATTRIBUT

Produkt: **HS7280**

	Angle 45°		S		Flush
	0.2-0.8 mm		0.01-0.03 in	A	150.3 mm
A	5.91 in	B	18 mm	B	0.71 in
C	9 mm	C	0.35 in	D	6 mm
D	0.24 inch	G	3.5 mm	G	0.14 in
	102 g	Ω	Dissipative		