



**RX 8136-RX 8168**  
**ERGO™ sidavbitare med**  
**avsmalnande urfräst huvud**







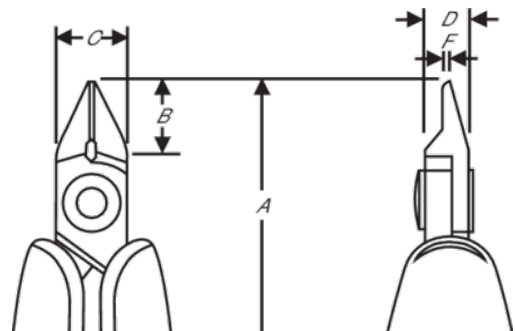

## PRODUKTINFORMATION







- Sidavbitare med avsmalnande urfräst huvud utvecklad enligt en vetenskaplig ERGO™-process
- Extra avfasat och urfräst huvud
- ERGO™-tvåkomponentshandtag av stark polypropen med termoplastisk yta för ett bekvämt grepp
- Plant och ultra-plant snitt
- Klippkapaciteten avser koppartråd
- Klippkapacitet: 0,1 mm - 0,8 mm
- Högkvalitativ stållegering
- Fosfaterad yta
- Numeriskt styrd maskinslipning som garanterar precisionen på eggvinkel och kontakt, vilket ökar verktygets pålitlighet och likformighet
- Precisionsinduktionshårdad egg, 63-65 HRC
- Skruvad led som minskar friktionen och maximerar käftlinjeringen
- ESD-säkra handtag av tvåkomponents syntetmaterial
- BioSpring, en mjuk retur fjäder som ger lågt motstånd under arbetet och som kan justeras i 3 positioner eller tas bort helt
- Idealisk för arbete i trånga utrymmen









**Produkt: RX8136**

	Tapered & Relieved		XS		Micro-Bevel®
	0.1-0.8 mm		0.004-0.03 in	<b>A</b>	108 mm
<b>A</b>	4.25 in	<b>B</b>	8 mm	<b>B</b>	0.31 in
<b>C</b>	8 mm	<b>C</b>	0.31 in	<b>D</b>	5 mm
<b>D</b>	0.2 inch	<b>F</b>	0.8 mm	<b>F</b>	0.03 in
	66 g		Dissipative		







**Produkt: RX 8137**

	Tapered & Relieved		XS		Flush
	0.1-0.8 mm		0.004-0.03 in	<b>A</b>	108 mm
<b>A</b>	4.25 in	<b>B</b>	8 mm	<b>B</b>	0.31 in
<b>C</b>	8 mm	<b>C</b>	0.31 in	<b>D</b>	5 mm
<b>D</b>	0.2 inch	<b>F</b>	0.8 mm	<b>F</b>	0.03 in
	66 g		Dissipative		







**Produkt: RX8138**

	Tapered & Relieved		XS		Ultra-Flush®
	0.1-0.5 mm		0.004-0.02 in	<b>A</b>	108 mm
<b>A</b>	4.25 in	<b>B</b>	8 mm	<b>B</b>	0.31 in
<b>C</b>	8 mm	<b>C</b>	0.31 in	<b>D</b>	5 mm
<b>D</b>	0.2 inch	<b>F</b>	0.8 mm	<b>F</b>	0.03 in
	66 g		Dissipative		







**Produkt: RX 8146**

	Tapered & Relieved		S		Micro-Bevel®
	0.2-1.0 mm		0.01-0.04 in	<b>A</b>	135.5 mm
<b>A</b>	5.25 in	<b>B</b>	10.5 mm	<b>B</b>	0.41 in
<b>C</b>	10 mm	<b>C</b>	0.39 in	<b>D</b>	6 mm
<b>D</b>	0.24 inch	<b>F</b>	0.8 mm	<b>F</b>	0.03 in
	68 g		Dissipative		







**Produkt: RX 8147**

	Tapered & Relieved		S		Flush
	0.1-1.0 mm		0.00-0.04 in	<b>A</b>	135.5 mm
<b>A</b>	5.25 in	<b>B</b>	10.5 mm	<b>B</b>	0.41 in
<b>C</b>	10 mm	<b>C</b>	0.39 in	<b>D</b>	6 mm
<b>D</b>	0.24 inch	<b>F</b>	0.8 mm	<b>F</b>	0.03 in
	68 g		Dissipative		







**Produkt: RX 8148**

	Tapered & Relieved		S		Ultra-Flush®
	0.1-0.8 mm		0.00-0.03 in	<b>A</b>	135.5 mm
<b>A</b>	5.25 in	<b>B</b>	10.5 mm	<b>B</b>	0.41 in
<b>C</b>	10 mm	<b>C</b>	0.39 in	<b>D</b>	6 mm
<b>D</b>	0.24 inch	<b>F</b>	0.8 mm	<b>F</b>	0.03 in
	68 g		Dissipative		







**Produkt: RX 8156**

	Tapered & Relieved		M		Micro-Bevel®
	0.3-1.25 mm		0.01-0.05 in	<b>A</b>	138 mm
<b>A</b>	5.30 in	<b>B</b>	13 mm	<b>B</b>	0.51 in
<b>C</b>	12.5 mm	<b>C</b>	0.49 in	<b>D</b>	6 mm
<b>D</b>	0.24 inch	<b>F</b>	1.2 mm	<b>F</b>	0.05 in
	70 g		Dissipative		







**Produkt: RX 8157**

	Tapered & Relieved		M		Flush
	0.2-1.25 mm		0.01-0.05 in	<b>A</b>	138 mm
<b>A</b>	5.30 in	<b>B</b>	13 mm	<b>B</b>	0.51 in
<b>C</b>	12.5 mm	<b>C</b>	0.49 in	<b>D</b>	6 mm
<b>D</b>	0.24 inch	<b>F</b>	1.2 mm	<b>F</b>	0.05 in
	70 g		Dissipative		







**Produkt: RX 8158**

	Tapered & Relieved		M		Ultra-Flush®
	0.2-1.0 mm		0.01-0.04 in	<b>A</b>	138 mm
<b>A</b>	5.30 in	<b>B</b>	13 mm	<b>B</b>	0.51 in
<b>C</b>	12.5 mm	<b>C</b>	0.49 in	<b>D</b>	6 mm
<b>D</b>	0.24 inch	<b>F</b>	1.2 mm	<b>F</b>	0.05 in
	70 g		Dissipative		







**Produkt: RX8166**

	Tapered & Relieved		L		Micro-Bevel®
	0.4-1.5 mm		0.02-0.06 in	<b>A</b>	147 mm
<b>A</b>	5.80 in	<b>B</b>	16 mm	<b>B</b>	0.63 in
<b>C</b>	16 mm	<b>C</b>	0.63 in	<b>D</b>	8 mm
<b>D</b>	0.31 inch	<b>F</b>	1.6 mm	<b>F</b>	0.06 in
	139 g		Dissipative		

**Produkt: RX 8167**

	Tapered & Relieved		L		Flush
	0.3-1.5 mm		0.01-0.06 in	<b>A</b>	147 mm
<b>A</b>	5.80 in	<b>B</b>	16 mm	<b>B</b>	0.63 in
<b>C</b>	16 mm	<b>C</b>	0.63 in	<b>D</b>	8 mm
<b>D</b>	0.31 inch	<b>F</b>	1.6 mm	<b>F</b>	0.06 in
	139 g		Dissipative		

**Produkt: RX 8168**

	Tapered & Relieved		L		Ultra-Flush®
	0.3-1.25 mm		0.01-0.05 in	<b>A</b>	147 mm
<b>A</b>	5.80 in	<b>B</b>	16 mm	<b>B</b>	0.63 in
<b>C</b>	16 mm	<b>C</b>	0.63 in	<b>D</b>	8 mm
<b>D</b>	0.31 inch	<b>F</b>	1.6 mm	<b>F</b>	0.06 in
	139 g		Dissipative		