



7892

## 60° bockad spetstång med enkomponentshandtag





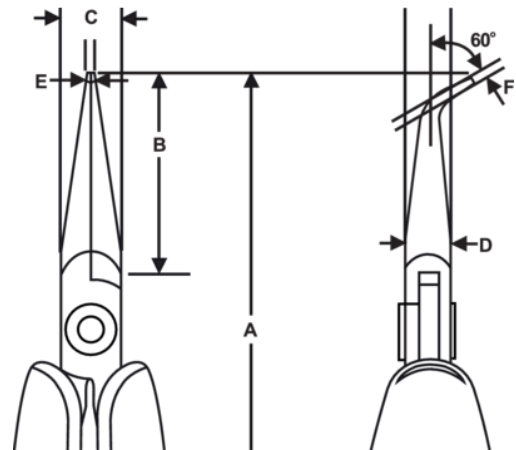

### PRODUKTINFORMATION

- Spetstång, bockad, Supreme-serien
- ESD-säkra handtag i enkomponentsmaterial med retur fjäder
- Högkvalitativ stållegering
- Polerad yta
- Slipning med numeriskt styrda maskiner garanterar noggrann eggbearbetning och hög prestanda
- Induktionshårdade käftar till en hårdhet av 42 - 46 HRc
- Skruvad led som minimerar friktion och maximerar käftlinjering
- 29 mm släta käftar med 60° avrundade kanter







PRODUKTATTRIBUT

Produkt: **7892**

	Bent Nose		M	<b>A</b>	129 mm
<b>A</b>	5.08 in	<b>B</b>	29 mm	<b>B</b>	1.14 in
<b>C</b>	9 mm	<b>C</b>	0.35 in	<b>D</b>	6 mm
<b>D</b>	0.24 inch	<b>E</b>	1.2 mm	<b>E</b>	0.05 in
<b>F</b>	0.8 mm	<b>F</b>	0.03 in		Smooth
	73 g	<b>Ω</b>	Dissipative		

Produkt: **7892 CO**

	Bent Nose		M	<b>A</b>	129 mm
<b>A</b>	5.08 in	<b>B</b>	29 mm	<b>B</b>	1.14 in
<b>C</b>	9 mm	<b>C</b>	0.35 in	<b>D</b>	6 mm
<b>D</b>	0.24 inch	<b>E</b>	1.2 mm	<b>E</b>	0.05 in
<b>F</b>	0.8 mm	<b>F</b>	0.03 in		Smooth
	73 g	<b>Ω</b>	Conductive		