

7890-7891

Spetstång med enkomponentshandtag





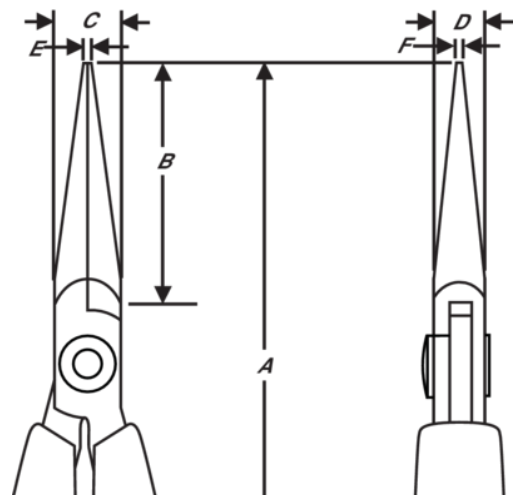

PRODUKTINFORMATION

- Spetstång, Supreme-serien
- ESD-säkra handtag i enkomponentsmaterial med retur fjäder
- Högkvalitativ stållegering
- Polerad yta
- Slipning med numeriskt styrda maskiner garanterar noggrann eggbearbetning och hög prestanda
- Induktionshårdade käftar till en hårdhet av 42 - 46 HRc
- Skruvad led som minimerar friktion och maximerar käftlinjering
- 32 mm käftar med rundade hörn
- CO: Standard handtagsform, konduktiva







PRODUKTATTRIBUT





Produkt: 7890

	Chain Nose		M	A	132 mm
A	5.20 in	B	32 mm	B	1.26 in
C	9 mm	C	0.35 in	D	6 mm
D	0.24 inch	E	1.2 mm	E	0.05 in
F	0.8 mm	F	0.03 in		Smooth
	72 g	Ω	Dissipative		





Produkt: 7891

	Chain Nose		M	A	132 mm
A	5.20 in	B	32 mm	B	1.26 in
C	9 mm	C	0.35 in	D	6 mm
D	0.24 inch	E	1.2 mm	E	0.05 in
F	0.8 mm	F	0.03 in		Serrated
	72 g	Ω	Dissipative		

Produkt: 7890 CO

	Chain Nose		M	A	132 mm
A	5.20 in	B	32 mm	B	1.26 in
C	9 mm	C	0.35 in	D	6 mm
D	0.24 inch	E	1.2 mm	E	0.05 in
F	0.8 mm	F	0.03 in		Smooth
	60 g	Ω	Conductive		

Produkt: 7891 CO

	Chain Nose		M	A	132 mm
A	5.20 in	B	32 mm	B	1.26 in
C	9 mm	C	0.35 in	D	6 mm
D	0.24 inch	E	1.2 mm	E	0.05 in
F	0.8 mm	F	0.03 in		Serrated
	59 g	Ω	Conductive		