



7280

Snedavbitare med omvänd vinkel
0,2 mm - 0,8 mm







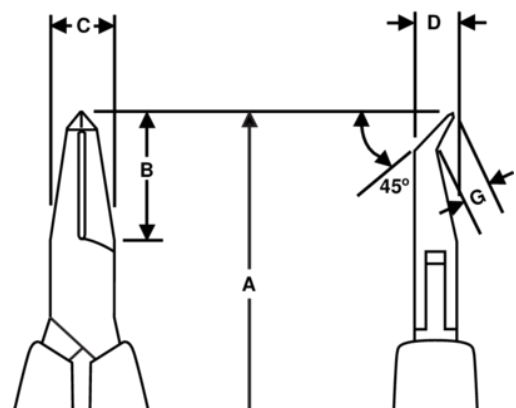

PRODUKTINFORMATION

- Supreme-serien snedavbitare med omvänd vinkel
- ESD-säkra handtag i enkomponentsmaterial med retur fjäder
- Plant snitt
- Klippkapacitet angiven för koppartråd
- För klippning av koppartråd
- Högkvalitativ stållegering
- Polerad yta
- Slipning med numeriskt styrda maskiner garanterar noggrann eggbearbetning och gör verktygen pålitliga och hållbara
- Induktionshårdade skäreppgar till en hårdhet av 58 - 60 HRC
- Skruvad led som minimerar friktion och maximerar käftlinjering
- Idealisk för trånga utrymmen



PRODUKTATTRIBUT

Produkt: **7280**

| | | | | | |
|---|-----------|---|--------------|---|---------|
|  | Angle 45° |  | S |  | Flush |
|  | 0.2-08 mm |  | 0.01-0.03 in | A | 120 mm |
| A | 4.72 in | B | 20 mm | B | 0.79 in |
| C | 9 mm | C | 0.35 in | D | 6 mm |
| D | 0.24 inch | F | 3.5 mm | F | 0.14 in |
|  | 56 g | Ω | Dissipative | | |