



8247

Snedavbitare 45° långt huvud 0,2 mm-1 mm







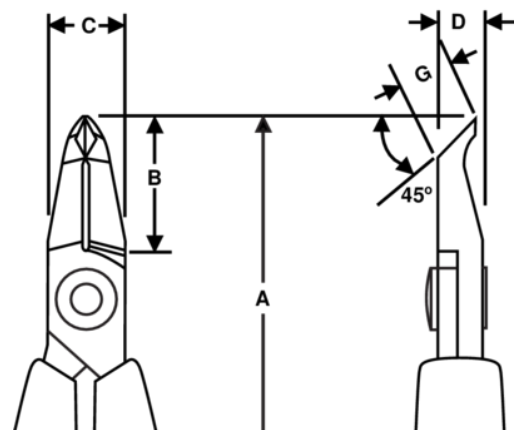

PRODUKTINFORMATION

- Snedavbitare 45° avsmalnande huvud, 80-serien
- ESD-säkra handtag i enkomponentsmaterial med retur fjäder
- Plant snitt
- Klippkapacitet angiven för kopparkabel
- För klippning av koppar
- Högkvalitativ stållegering
- Svartoxiderad yta
- Slipning med numeriskt styrda maskiner garanterar noggrann eggbearbetning
- Induktionshärdade skäreppgar till en hårdhet av 63 - 65 HRC
- Skruvad led som minimerar friktion och maximerar käftlinjering
- Idealisk för arbete med komponentdetaljer
- CO: Standard handtagsform, konduktiva









PRODUKTATTRIBUT

Produkt: **8247**

	Angle 45°		S		Flush
	0.2-1.0 mm		0.01-0.04 in	A	117.5 mm
A	4.63 in	B	18 mm	B	0.71 in
C	10 mm	C	0.39 in	D	6 mm
D	0.24 inch	G	6.7 mm	G	0.26 in
	51 g		Dissipative		

Produkt: **8247 CO**

	Angle 45°		S		Flush
	0.2-1.0 mm		0.01-0.04 in	A	117.5 mm
A	4.63 in	B	18 mm	B	0.71 in
C	10 mm	C	0.39 in	D	6 mm
D	0.24 inch	G	6.7 mm	G	0.26 in
	51 g		Conductive		