



7280

Snedavbitare med omvänd vinkel
0,2 mm - 0,8 mm







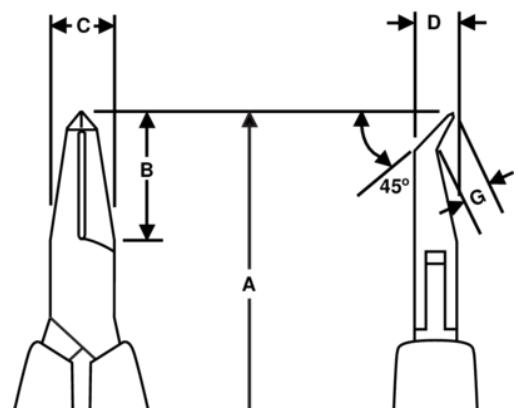

PRODUKTINFORMATION

- Supreme-serien snedavbitare med omvänd vinkel
- ESD-säkra handtag i enkomponentsmaterial med retur fjäder
- Plant snitt
- Klippkapacitet angiven för koppartråd
- För klippning av koppartråd
- Högkvalitativ stållegering
- Polerad yta
- Slipning med numeriskt styrda maskiner garanterar noggrann eggbearbetning och gör verktygen pålitliga och hållbara
- Induktionshårdade skäreppar till en hårdhet av 58 - 60 HRC
- Skruvad led som minimerar friktion och maximerar käftlinjering
- Idealisk för trånga utrymmen



PRODUKTATTRIBUT

Produkt: **7280**

	Angle 45°		S		Flush
	0.2-08 mm		0.01-0.03 in	A	120 mm
A	4.72 in	B	20 mm	B	0.79 in
C	9 mm	C	0.35 in	D	6 mm
D	0.24 inch	F	3.5 mm	F	0.14 in
	56 g	Ω	Dissipative		