



6159

## Flush Edge Shear Cutter with Pointy Head







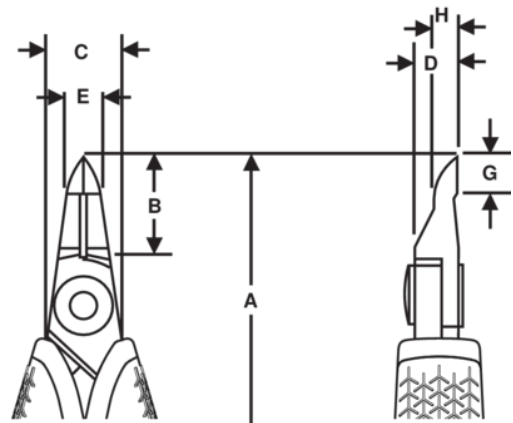

### PRODUCT DETAILS

- This model's unique, pointy head allows users to get underneath delicate components and execute flush EDGE cuts on hard-to-access wires.
- Perfect for fine mechanics, industrial electricians, mechatronics engineers, and microelectronics specialists.
- The pointy head design and its symmetrical tips have been specifically adapted to allow for maximum access and reach.
- Flush EDGE cut: Expert shear cutting technology and a controlled edge misalignment of less than 0.2 mm deliver a clean, smooth cut on even the thinnest wires.
- High-performance alloy steel body for excellent durability and long-lasting performance, with precision-ground cutting edges that are induction hardened at 63-65 HRC.
- Return spring and opening limiter for smooth operation that helps minimize hand fatigue.
- Bi-material and ESD-safe dissipative handles eliminate electrostatic buildup and permit a slow charge equalization.



PRODUCT ATTRIBUTES

Product: **6159**

	Pointy		M		Flush EDGE
	0.2-1.0 mm		0.01-0.039 in	<b>A</b>	134 mm
<b>A</b>	134 in	<b>B</b>	14 mm	<b>B</b>	0.55 in
<b>C</b>	12.8 mm	<b>C</b>	0.50 in	<b>D</b>	5 mm
<b>D</b>	0.2 inch	<b>E</b>	1 mm	<b>E</b>	0.04 in
<b>G</b>	5.0 mm	<b>G</b>	0.23 in	<b>H</b>	3.2 mm
<b>H</b>	0.13 in		54.4 g	<b>Ω</b>	Dissipative