



7590-7591

Round Nose Tipped Pliers with Synthetic Handle





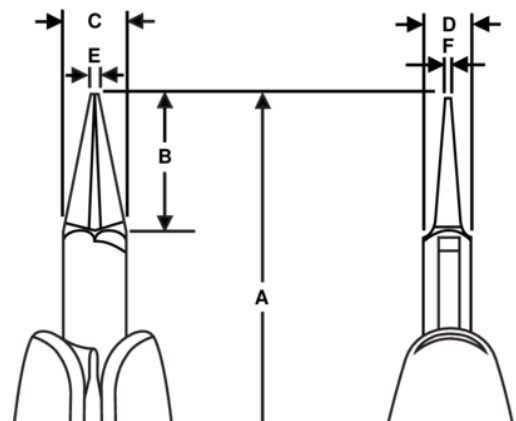

PRODUCT DETAILS

- Supreme series round nose pliers
- Round jaws taper from 7 mm to 1.0 mm at the tip
- ESD safe mono-material handles with return spring
- High performance alloyed steel
- Polished finish
- Numerically controlled machine grinding guarantees accuracy & increases the tools reliability & consistency
- Tough hardened 42-46 HRC
- Screw joint that minimizes friction & maximizes jaw alignment
- Round jaws with no sharp edges
- 7591 with long tip







PRODUCT ATTRIBUTES





Product: **7590**

	Round Nose		S	A	146.5 mm
A	5.77 in	B	20 mm	B	0.79 in
C	9 mm	C	0.35 in	D	6 mm
D	0.24 inch	E	1.4 mm	E	0.055 in
F	0.7 mm	F	0.027 in		Smooth
	69 g	Ω	Dissipative		

Product: **7590 CO**

	Round Nose		S	A	146.5 mm
A	5.77 in	B	20 mm	B	0.79 in
C	9 mm	C	0.35 in	D	6 mm
D	0.24 inch	E	1.4 mm	E	0.055 in
F	0.7 mm	F	0.027 in		Smooth
	54 g	Ω	Conductive		

Product: **7591**

	Round Nose		M	A	165 mm
A	6.5 in	B	38.5 mm	B	1.51 in
C	9 mm	C	0.35 in	D	6.7 mm
D	0.24 inch	E	1.4 mm	E	0.055 in
F	0.7 mm	F	0.027 in		Smooth
	75 g	Ω	Dissipative		