



**HS 8149**  
**Long Precision Diagonal Tip**  
**Cutters with ESD Safe Handle**







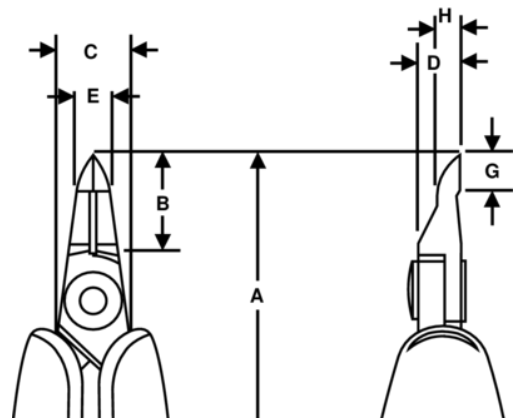

**PRODUCT DETAILS**

- HS series precision diagonal cutters with tip cut
- ESD safe long foam handles with return spring
- Flush cut
- The stated cutting capacity is for copper wire
- Suitable for cutting copper
- High performance alloy steel
- Burnished finish
- Numerically controlled machine grinding ensures edge angle accuracy and contact, increasing tool reliability and consistency
- Precision induction hardened edges 63-65 HRC
- Screw joint minimises friction and maximises alignment of cutting edges
- Ideal for use with multi-lead components and for rework



PRODUCT ATTRIBUTES

Product: **HS8149**

	Tip Cutter		S		Flush
	0.1-0.6 mm		0.01-0.02 in	<b>A</b>	146.3 mm
<b>A</b>	5.76 in	<b>B</b>	14 mm	<b>B</b>	0.55 in
<b>C</b>	5 mm	<b>C</b>	0.23 in	<b>D</b>	6 mm
<b>D</b>	0.24 inch	<b>E</b>	5 mm	<b>E</b>	0.23 in
<b>G</b>	5 mm	<b>G</b>	0.23 in	<b>H</b>	3.2 mm
<b>H</b>	0.13 in		90 g	<b>Ω</b>	Dissipative