



8149

## Precision Diagonal Tip Cutters with ESD Safe Handle







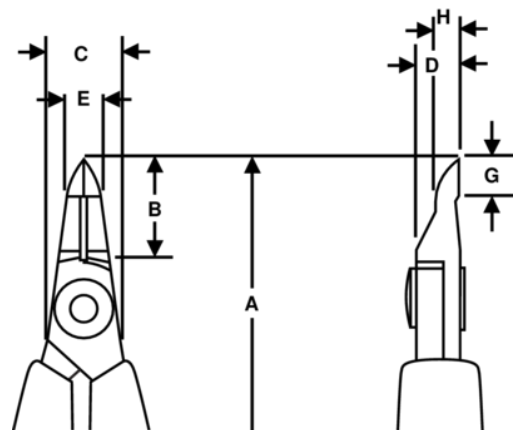
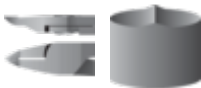

### PRODUCT DETAILS

- 80 Series precision diagonal cutters with tip cut
- ESD safe mono-material handles with return spring
- Flush cut
- The cutting capacity given is for copper wire
- Suitable for cutting Cu
- High performance alloyed steel
- Burnished finish
- Numerically controlled machine grinding guarantees edge angle accuracy & contact, increases the tools reliability & consistency
- Precision induction hardened edges 58-60 HRC
- Screw joint that minimizes friction & maximizes alignment of cutting edges
- Ideal for use with multi-lead components & for rework
- CO standard handle shape in conductive material



PRODUCT ATTRIBUTES

Product: **8149**

	Tip Cutter		S		Flush
	0.1-0.6 mm		0.00-0.02 in	<b>A</b>	114 mm
<b>A</b>	4.49 in	<b>B</b>	14 mm	<b>B</b>	0.55 in
<b>C</b>	5 mm	<b>C</b>	0.23 in	<b>D</b>	6 mm
<b>D</b>	0.24 inch	<b>E</b>	5 mm	<b>E</b>	0.23 in
<b>G</b>	5 mm	<b>G</b>	0.23 in	<b>H</b>	3.2 mm
<b>H</b>	0.13 in		48 g	<b>Ω</b>	Dissipative