



P6160 ERGO™ Precision Diagonal Plastic Cutters







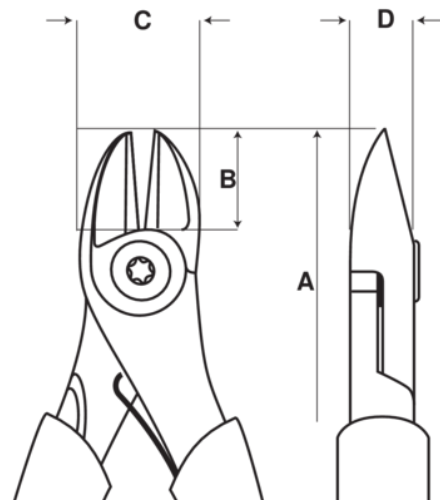



PRODUCT DETAILS

- Side cutting pliers developed according to the scientific ERGO™ process
- ERGO™ handles with two-component combination, thermoplastic surface on tough polypropylene to give a superior grip
- Full flush cutting edge without bevelling designed to smoothly cut all kinds of plastic parts
- Cutting capacity: Cu 1.5 mm & plastic material PA (Nylon) 3 mm
- High performance alloyed steel
- Burnished finish, anti-corrosion treated
- Screw joint provides excellent running & accurate alignment of the cutting edges
- Round shaped jaws give improved accessibility in confined spaces
- induction-hardened cutting edges
- Equipped with a return spring featuring & on/off function
- Dimensions according to ISO 5749



PRODUCT ATTRIBUTES

Product: **P6160**

	Oval		L		Flush
	1.5 mm		0.059 in		3.0 mm
	0.118 in	A	160 mm	A	6.3 in
B	18 mm	B	0.7 in	C	21.5 mm
C	0.85 in	D	10 mm	D	0.39 inch
	162 g				