



7892

60° Bent Tip Snipe Nose Pliers with Synthetic Handle





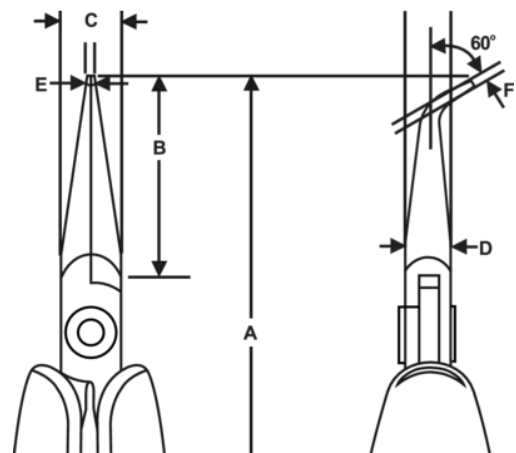

PRODUCT DETAILS

- Supreme series snipe nose pliers with bent tip
- ESD safe mono-material handles with return spring
- High performance alloyed steel
- Polished finish
- Numerically controlled machine grinding guarantees accuracy & increases the tools reliability & consistency
- Tough hardened 42-46 HRC
- Screw joint that minimizes friction & maximizes jaw alignment
- 29 mm of smooth jaws bent at 60° with radiused edges







PRODUCT ATTRIBUTES

Product: **7892**

	Bent Nose		M	A	129 mm
A	5.08 in	B	29 mm	B	1.14 in
C	9 mm	C	0.35 in	D	6 mm
D	0.24 inch	E	1.2 mm	E	0.05 in
F	0.8 mm	F	0.03 in		Smooth
	73 g	Ω	Dissipative		

Product: **7892 CO**

	Bent Nose		M	A	129 mm
A	5.08 in	B	29 mm	B	1.14 in
C	9 mm	C	0.35 in	D	6 mm
D	0.24 inch	E	1.2 mm	E	0.05 in
F	0.8 mm	F	0.03 in		Smooth
	73 g	Ω	Conductive		