



7280

**Precision 45° Reverse angle & HS
Long 45° Reverse Angle Cutters
0.2 mm-08 mm**







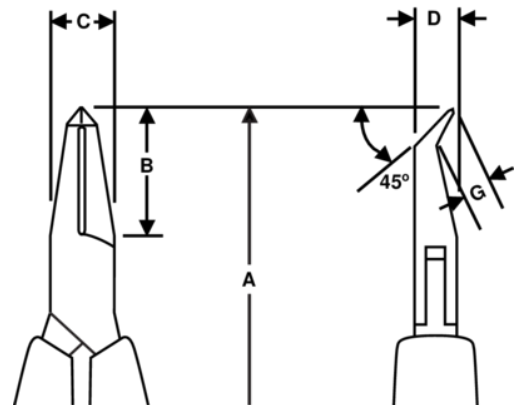

PRODUCT DETAILS

- Supreme series & reverse angle oblique cutter
- ESD safe mono-material handles with return spring
- Flush cut
- The cutting capacity given is for copper wire
- Suitable for cutting Cu
- High performance alloyed steel
- Polished finish
- Numerically controlled machine grinding guarantees edge angle accuracy & contact, increases the tools reliability & consistency
- Precision induction hardened edges 58-60 HRC
- Screw joint that minimizes friction & maximizes alignment of cutting edges
- Ideal for use in confined spaces



PRODUCT ATTRIBUTES

Product: **7280**

	Angle 45°		S		Flush
	0.2-08 mm		0.01-0.03 in	A	120 mm
A	4.72 in	B	20 mm	B	0.79 in
C	9 mm	C	0.35 in	D	6 mm
D	0.24 inch	F	3.5 mm	F	0.14 in
	56 g	Ω	Dissipative		