



## HS6000 Multipurpose Shear with Non-Slip Grips







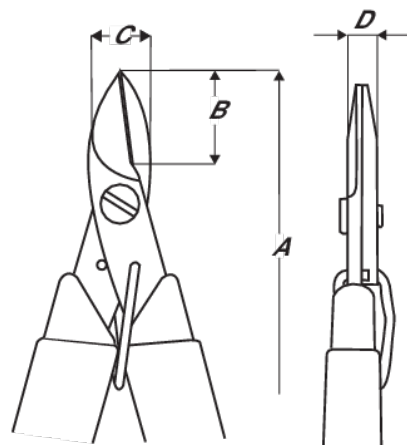

### PRODUCT DETAILS

- Kevlar cutter
- Designed to cut tough Kevlar elements used in fibre optic & other types of cables
- High carbon steel blades with a hardness of 57-59 HRC
- Serrations on one edge to prevent the material being cut from sliding away
- Precision screw joint minimises friction & maximises alignment of cutting edges
- User-friendly while optimising durability & precision
- Fits comfortably in either hand
- ESD safe non-slip grips provide cushioning & secure grasp
- Ideal for many other applications such as cutting insulation, cables, ties & corded material of all types









# PRODUCT ATTRIBUTES

## Product: HS6000

	Serrated-Jaws		L		Flush
	Kevlar	<b>A</b>	145 mm	<b>A</b>	5.7 in
<b>B</b>	29 mm	<b>B</b>	1.1 in	<b>C</b>	12.7 mm
<b>C</b>	0.5 in	<b>D</b>	6.4 mm	<b>D</b>	0.2 inch
	Serrated		88 g		Dissipative

## Product: HS6001

	Smooth-Jaws		L		Flush
	Kevlar	<b>A</b>	145 mm	<b>A</b>	5.7 in
<b>B</b>	29 mm	<b>B</b>	1.1 in	<b>C</b>	12.7 mm
<b>C</b>	0.5 in	<b>D</b>	6.4 mm	<b>D</b>	0.2 inch
	Smooth		88 g		Dissipative